

ED2205/X

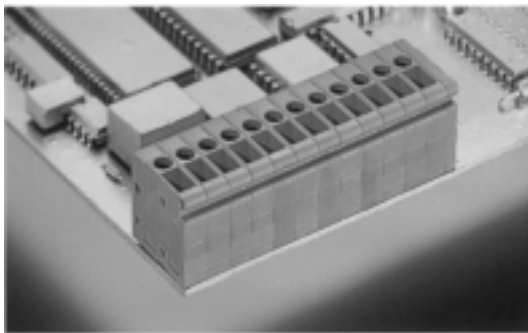

1-n poles, Spacing 5.0 mm
 insert required no. of poles **X**
 How to order see page 5



Ratings:

Rated Voltage	300V	250 V
Rated Current	20 A	24 A (T60)
Wire Size	AWG 30-12	2.5 mm ²
Test Voltage		2.0 kV
Rated Torque/ScrewSize		0.5 Nm/M2.5

Max. Rated Cross Section

Single Wire (solid)	2.5 mm ²
Stranded Wire (flexible)	2.5 mm ²
Stranded wire with Ferrules	2.5 mm ²

Dimensions

Spacing	5.0 mm
PCB Hole Diameter	1.3 mm
Stripped Length	9.0 mm

Materials

Insulating Material	PA
Flammability Class	UL94 V-0
Temperature Range	-30°C/+105°C
Clamp Cage	Fe/Fe
Wire Guard	Cu

Color

Green

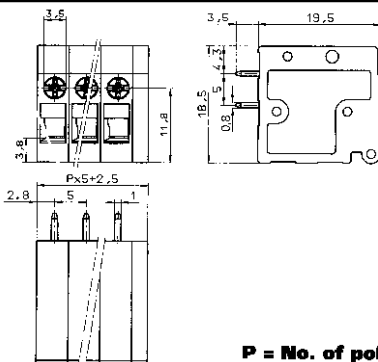

P = No. of poles